

REV. NO	DWG PART	REV. HISTORY	LTR	ECO NO	DATE	APPRL
00	00	INITIAL RELEASE	-	-	-	-

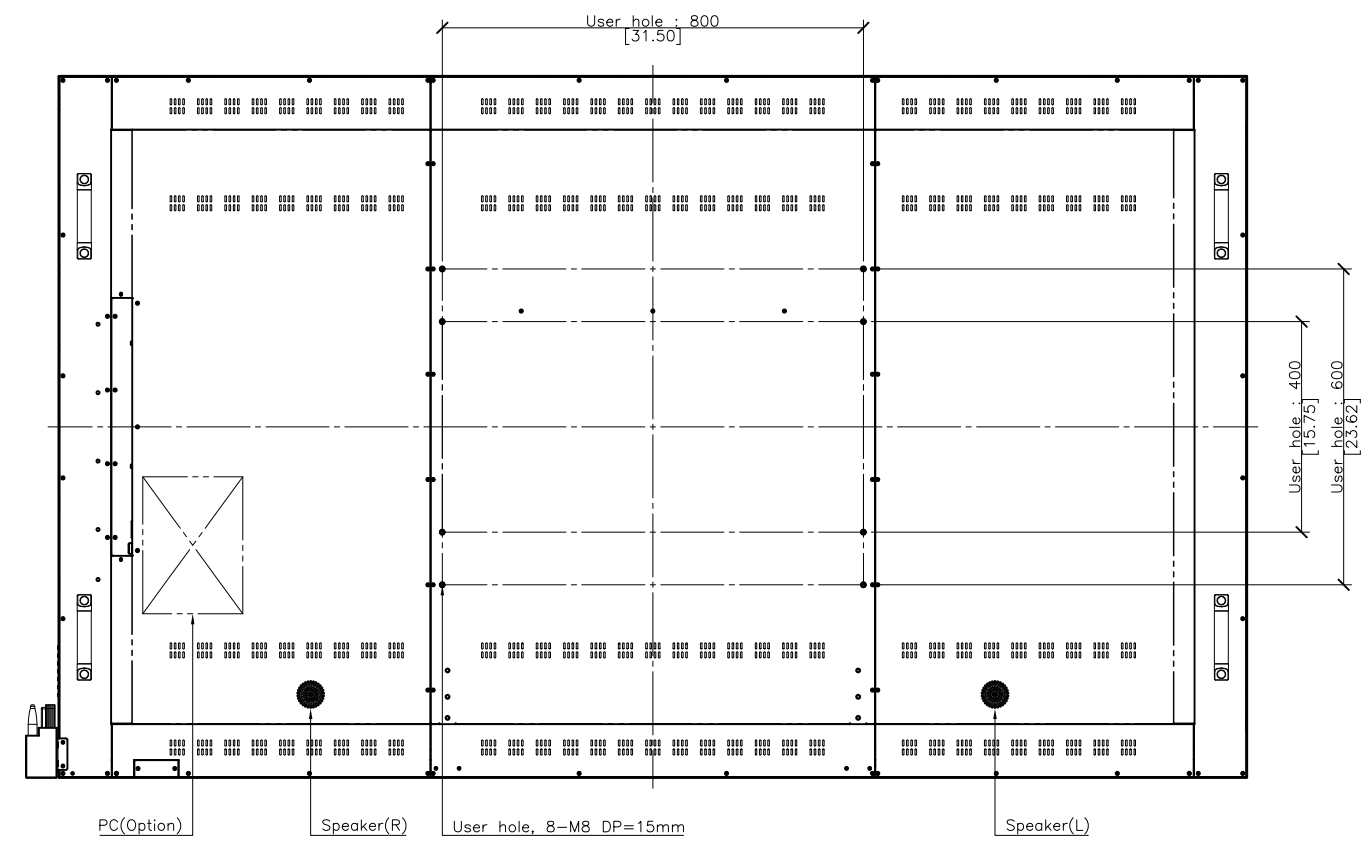
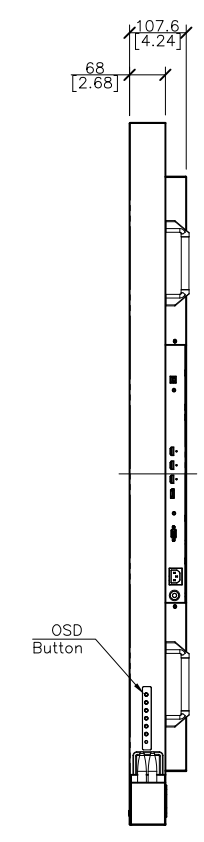
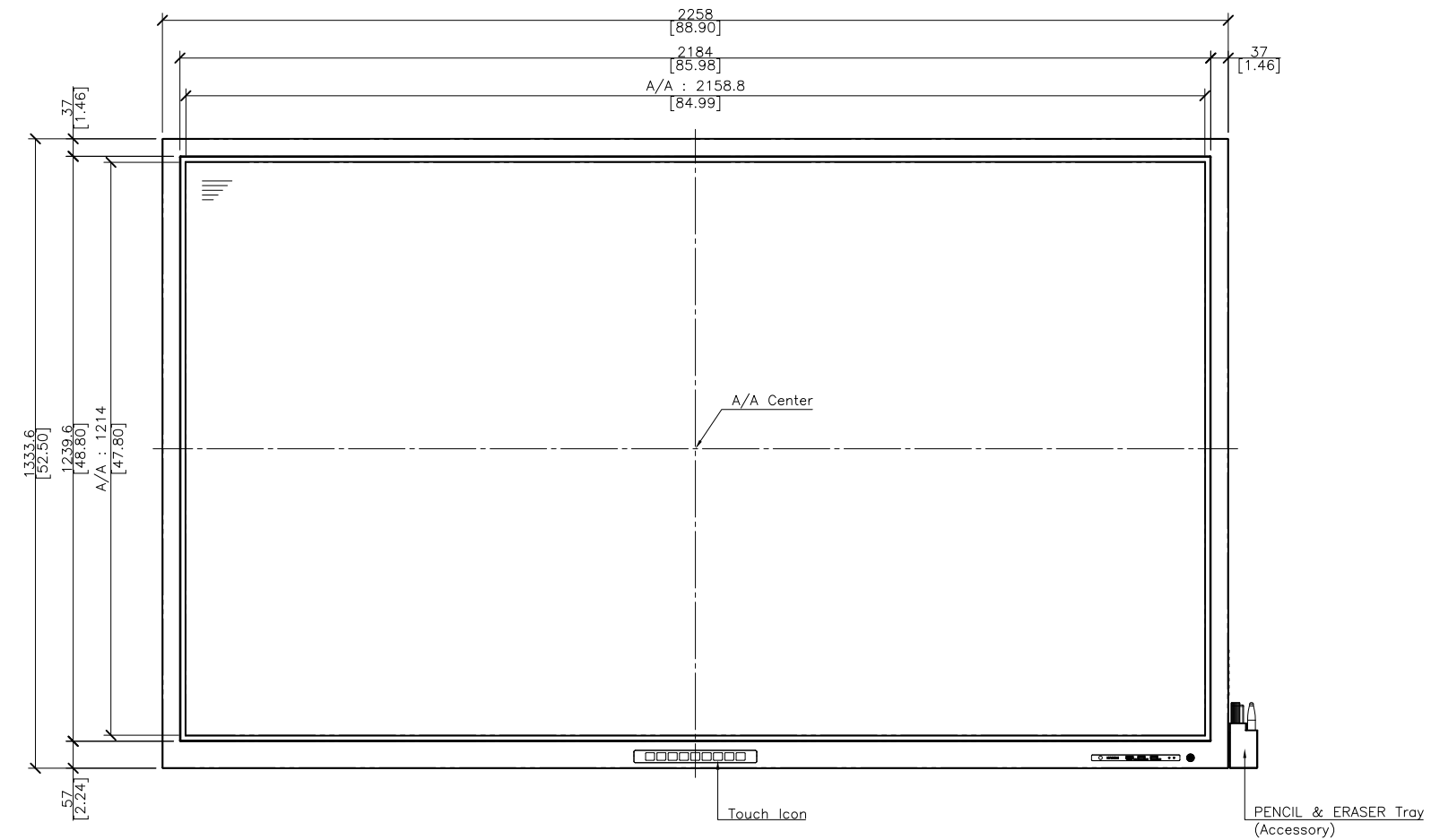
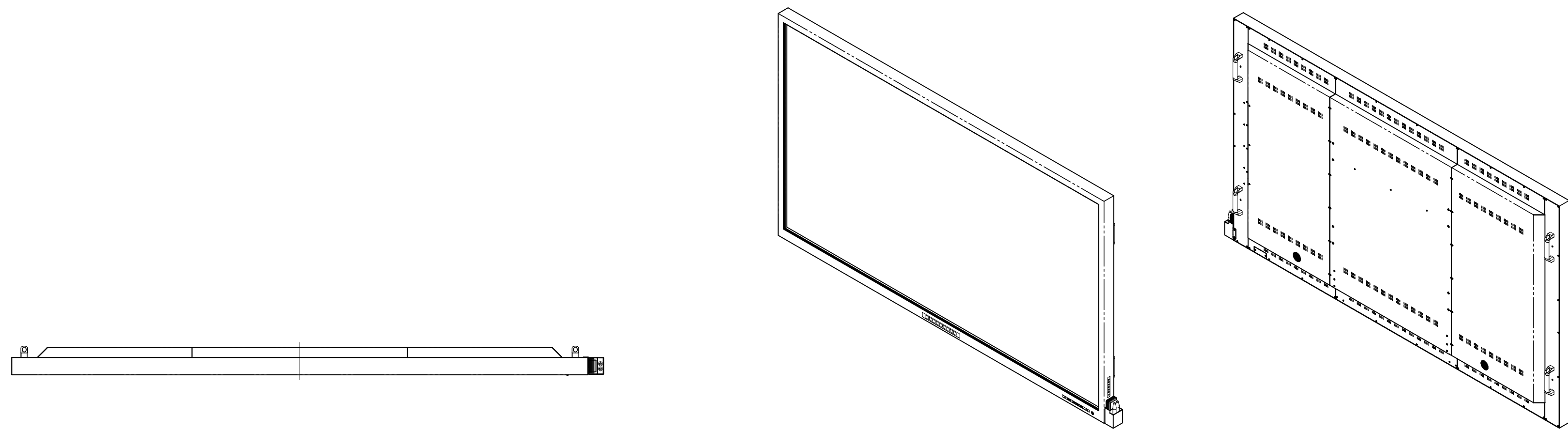

- NOTES,
 1. LCD Panel : 98"
 2. Tempered Glass : 5.0t
 3. Color : Black

DRAWN	PLANNED	CHECKED	APPROVED	UNLESS OTHERWISE SPECIFIED ALL DIMENSIONS ARE IN MILLIMETERS	ANGLE	TITLE	UNIT
S.W.SEO	S.H.AANG	S.H.AANG	Y.T.KIM	TOLERANCES ARE: DIMENSIONS X ±0.10 X ±0.1 XX ±0.01	30°	E98UAEL EXTERIOR VIEW	mm
18.11.17	18.11.17	18.11.17	18.11.17	ANGLES: RADI UNLESS NOTED R.03	SCALE: NS	E98UAEL_001	PART
HYUNDAI IT CO., LTD.				MODEL NAME (CODE): E98UAEL	CUSTOMER HDT	DWG REV : 00	SIZE: A1
				FILE NAME: LAYOUT_E98UAEL_171110.DWG	SHT NO : 1/1	DWG(PART) NO. E98UAEL_001	

This drawing is the property of HYUNDAI IT CO., LTD. and should not be disclosed to any third party without prior permission of HYUNDAI IT CO., LTD.

REV. NO	DWG PART	REV. HISTORY	LTR	ECO NO	DATE	APPRL
00	00	INITIAL RELEASE	-	-	-	-

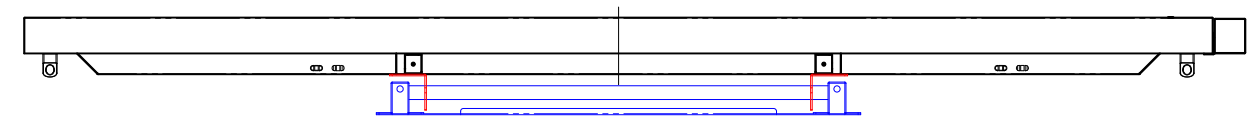
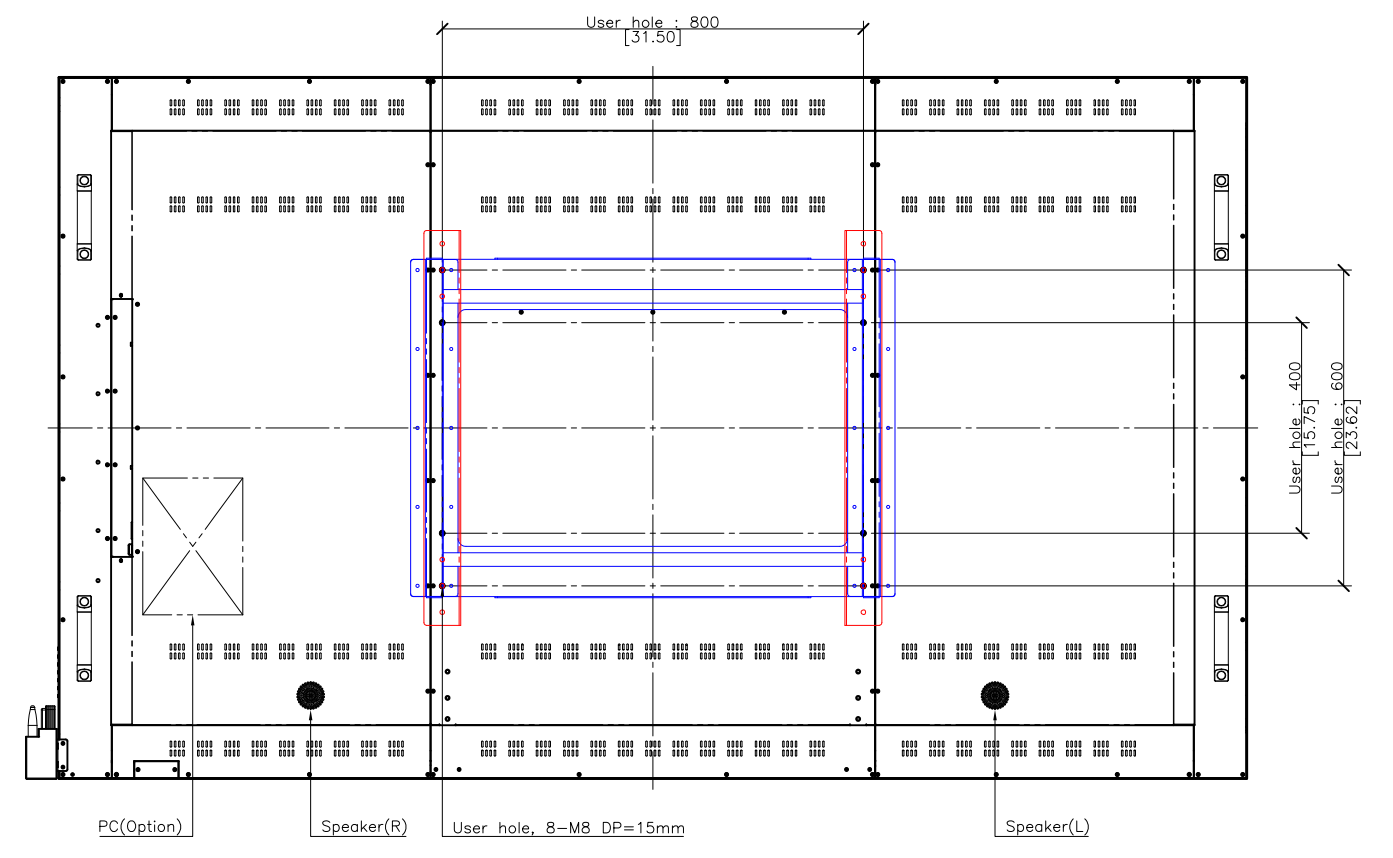
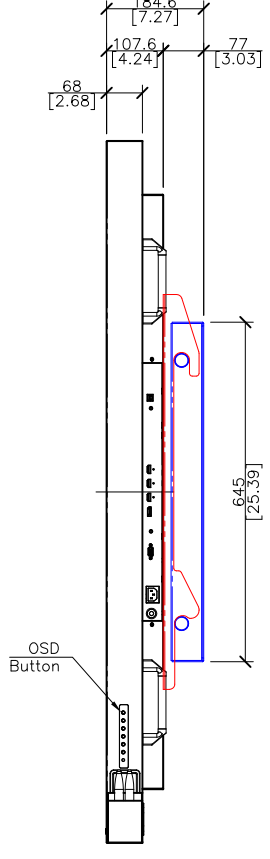
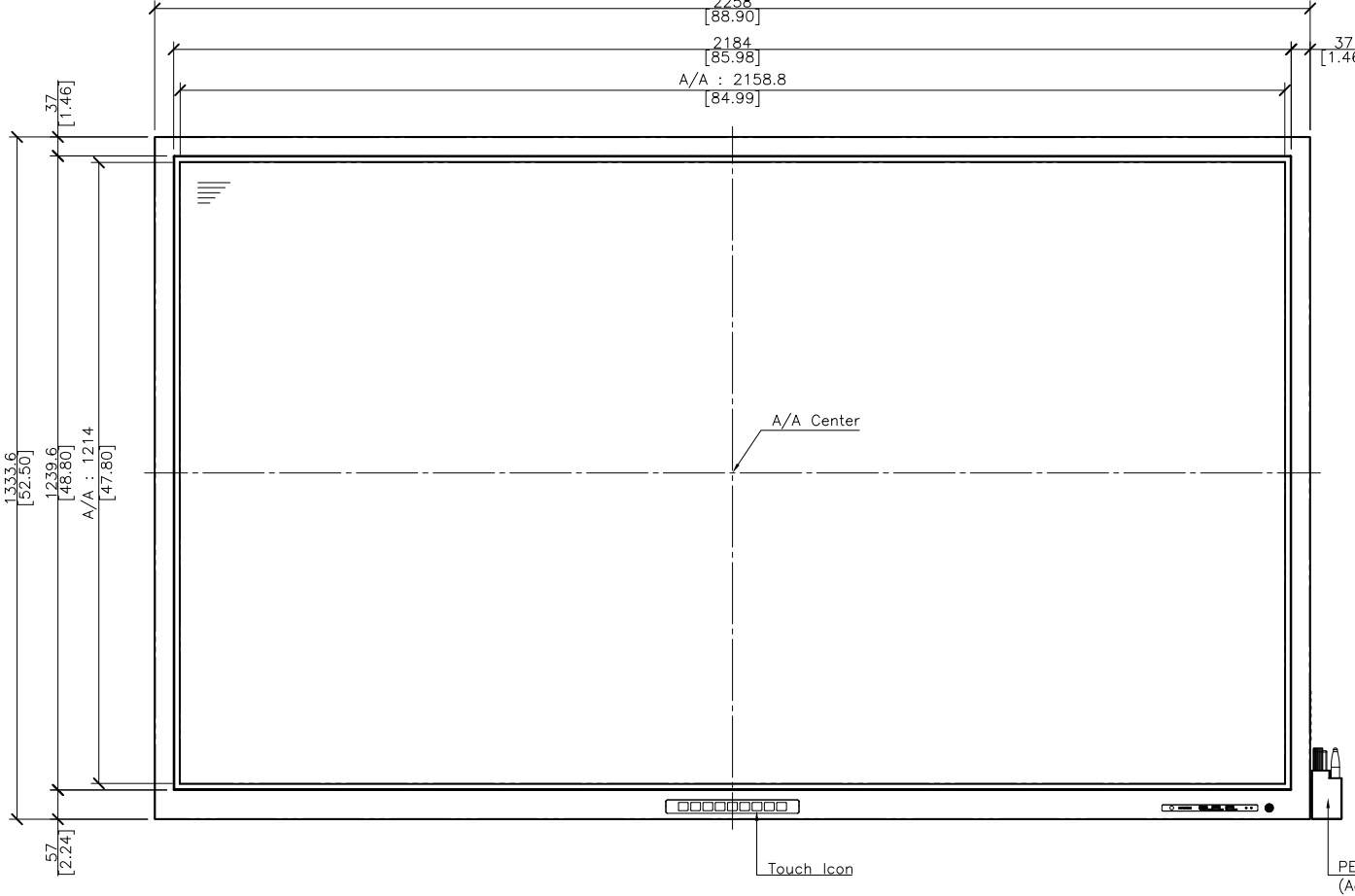
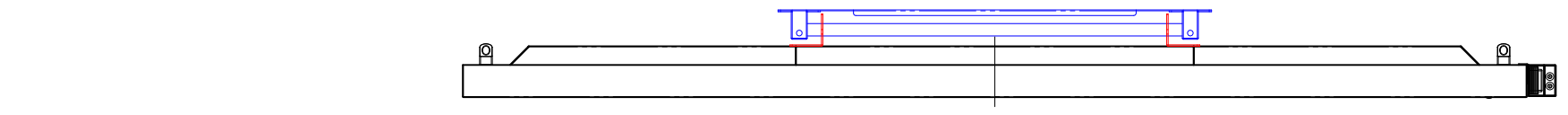

- NOTES
- LCD Panel : 98"
 - Tempered Glass : 5.0t
 - Color : Black

DRAWN	PLANNED	CHECKED	APPROVED	UNLESS OTHERWISE SPECIFIED ALL DIMENSIONS ARE IN MILLIMETERS	ANGLE	TITLE	UNIT
S.W.SHO	S.H.JANG	S.H.JANG	Y.T.KIM	TOLERANCES ARE ANGLES : X ± 0.1° X ± 0.1° XX ± 0.01° RADIUS UNLESS NOTED : R 0.3	30°	E98UAEL EXTERIOR VIEW	mm
18.11.17	18.11.17	18.11.17	18.11.17		SCALE : NS	DWG(PART) NO. E98UAEL_001	PART
HYUNDAI IT CO., LTD.				MODEL NAME (CODE) : E98UAEL	CUSTOMER : HDT	DWG REV : 00	SIZE : A1
				FILE NAME : LAYOUT_E98UAEL_171118.DWG	SHEET NO : 1/1		

This drawing is the property of HYUNDAI IT CO., LTD. and should not be disclosed to any third party without prior permission of HYUNDAI IT CO., LTD.

REV. NO	DWG PART	REV. HISTORY	LTR	ECO NO	DATE	APPRL
00	00	INITIAL RELEASE	-	-	-	-

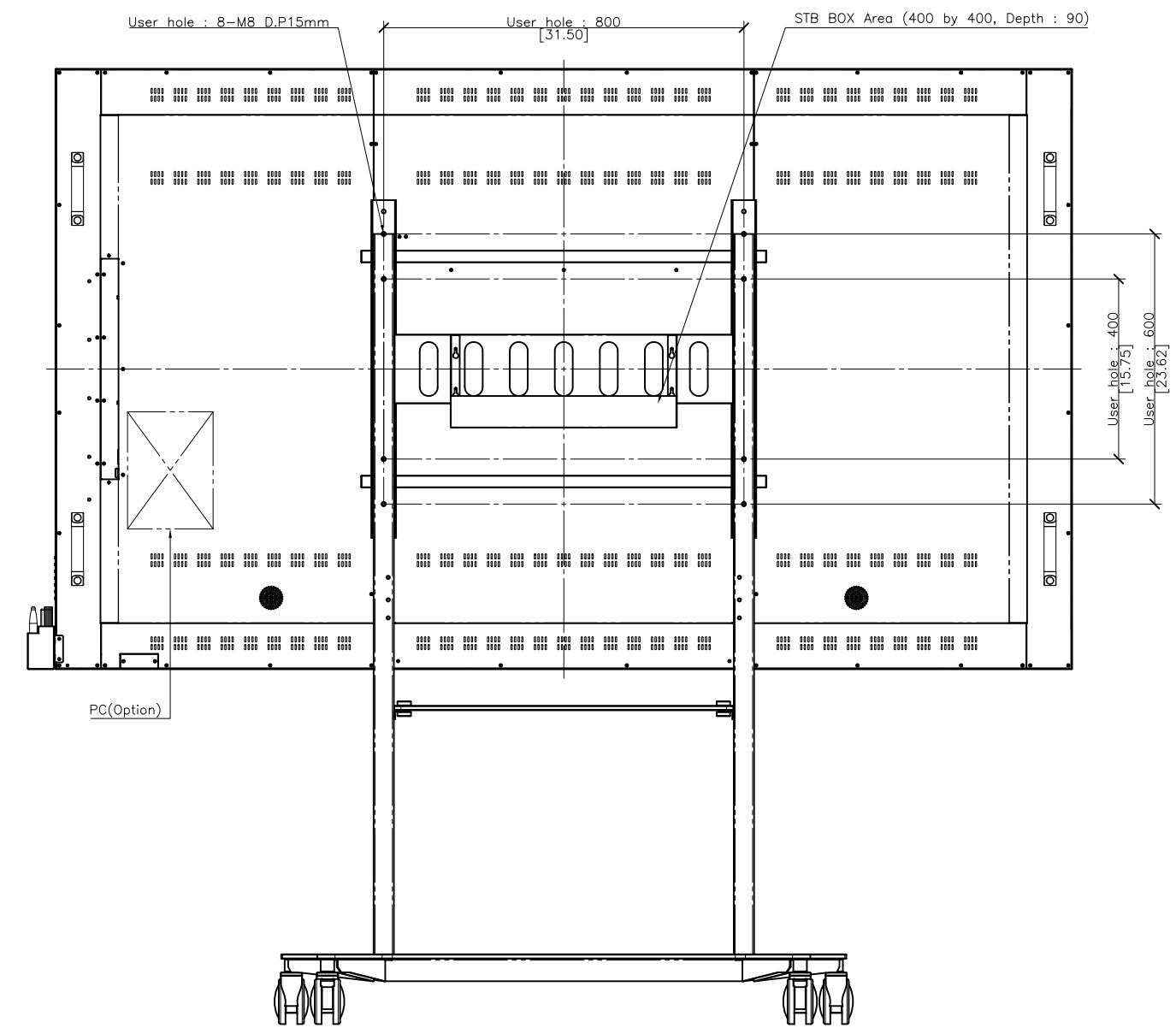
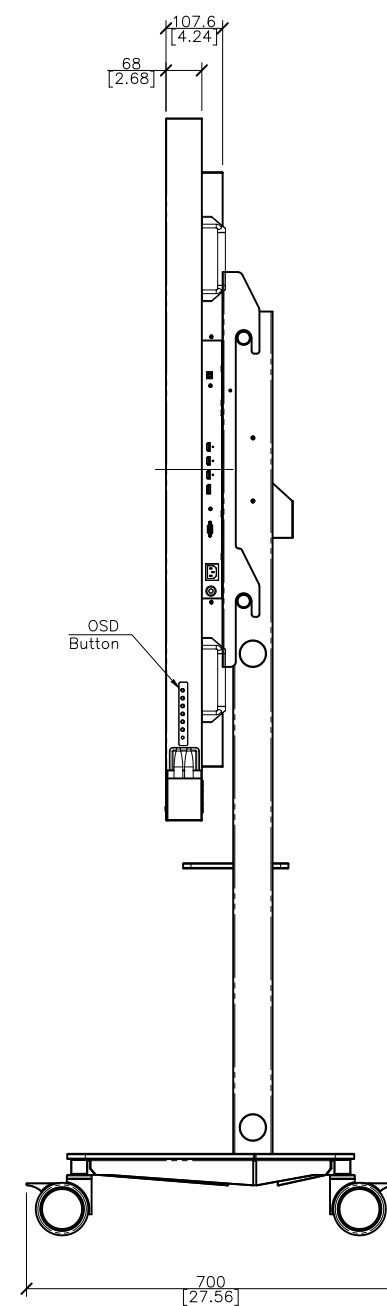
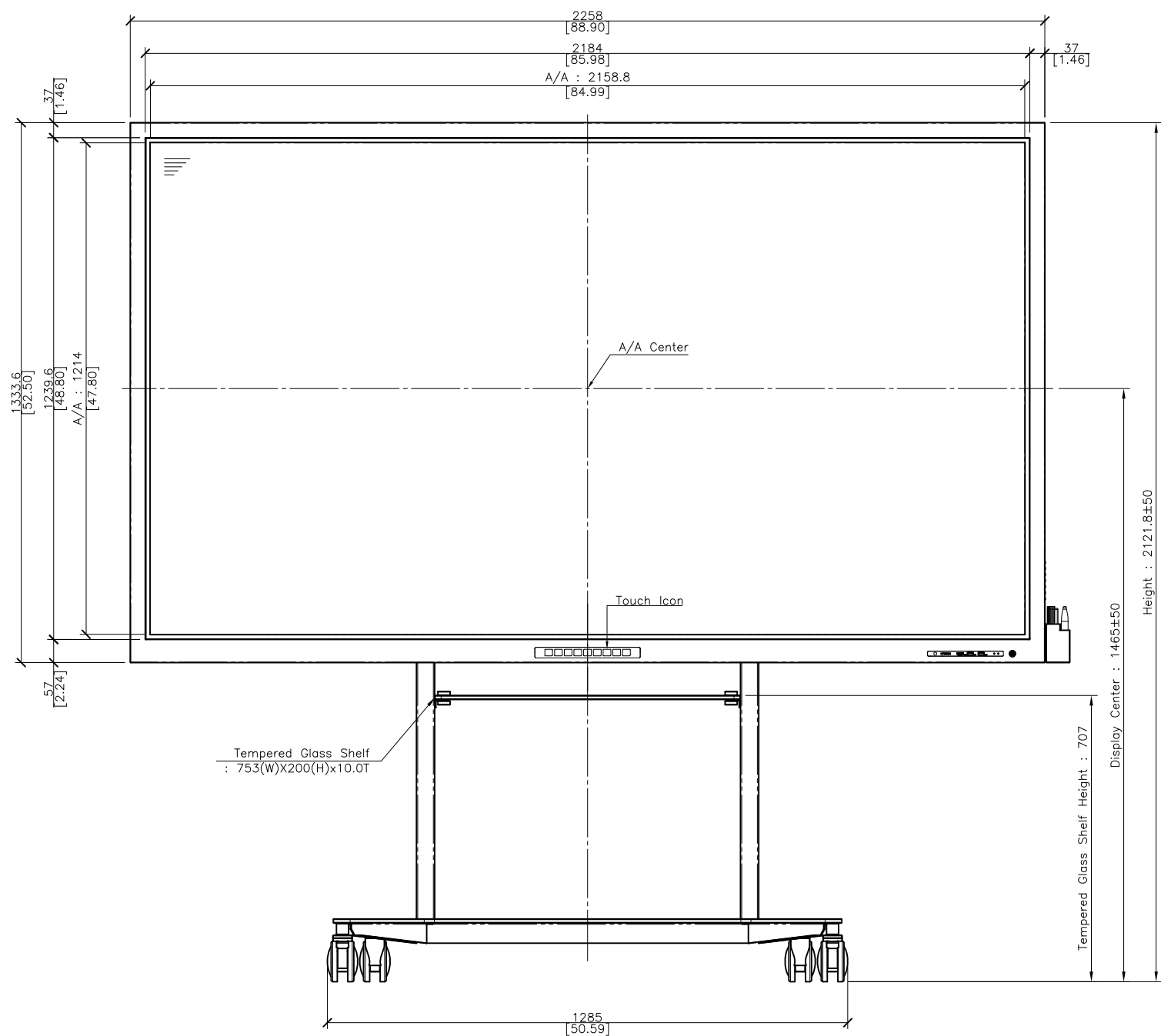

- NOTES
- LCD Panel : 98"
 - Tempered Glass : 5.0t
 - Color : Black

DRAWN	PLANNED	CHECKED	APPROVED	UNLESS OTHERWISE SPECIFIED ALL DIMENSIONS ARE IN MILLIMETERS	ANGLE	TITLE	UNIT
S.W.SHO	S.H.JANG	S.H.JANG	Y.T.KIM	TOLERANCES ARE: DIMEN. X ± 0.10 X ± 0.1 XX ± 0.01	30°	E98UAEL EXTERIOR VIEW	mm
18.11.17	18.11.17	18.11.17	18.11.17	ANGLES: RADI UNLESS NOTED R.03	SCALE: NS		TYPE: PART
HYUNDAI IT CO., LTD.		MODEL NAME (CODE): E98UAEL	CUSTOMER HDT	DWG REV : 00	DWG(PART) NO. E98UAEL_001		SIZE: A1
		FILE NAME: LAYOUT_E98UAEL_171110.DWG		SHT NO : 1/1			

REV. NO	DWG PART	REV. HISTORY	LTR	ECO NO	DATE	APPRL
00	00	INITIAL RELEASE	-	-	-	-

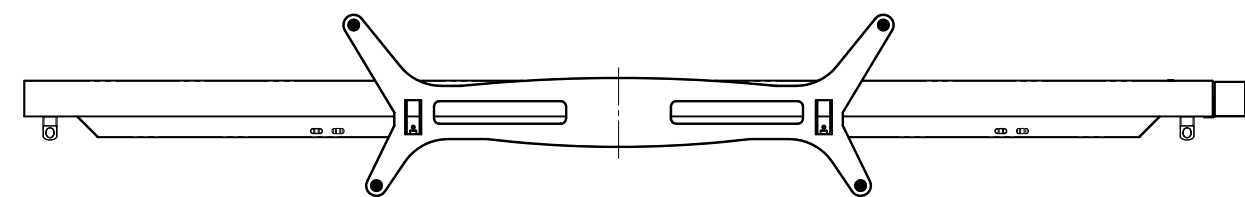
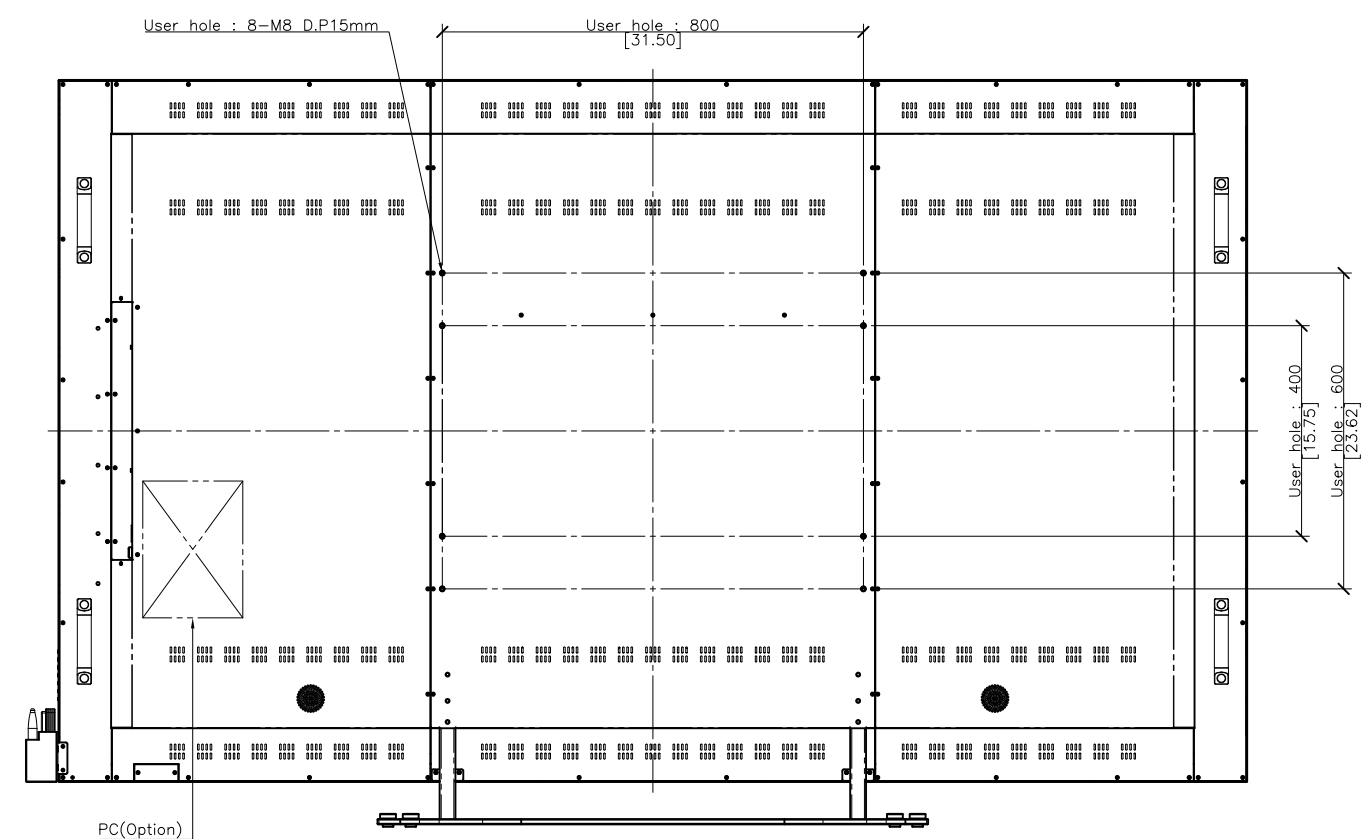
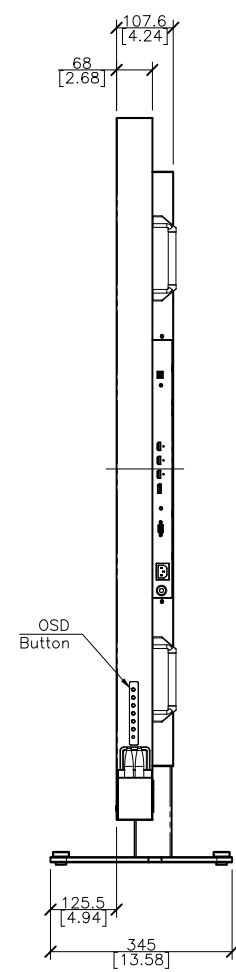
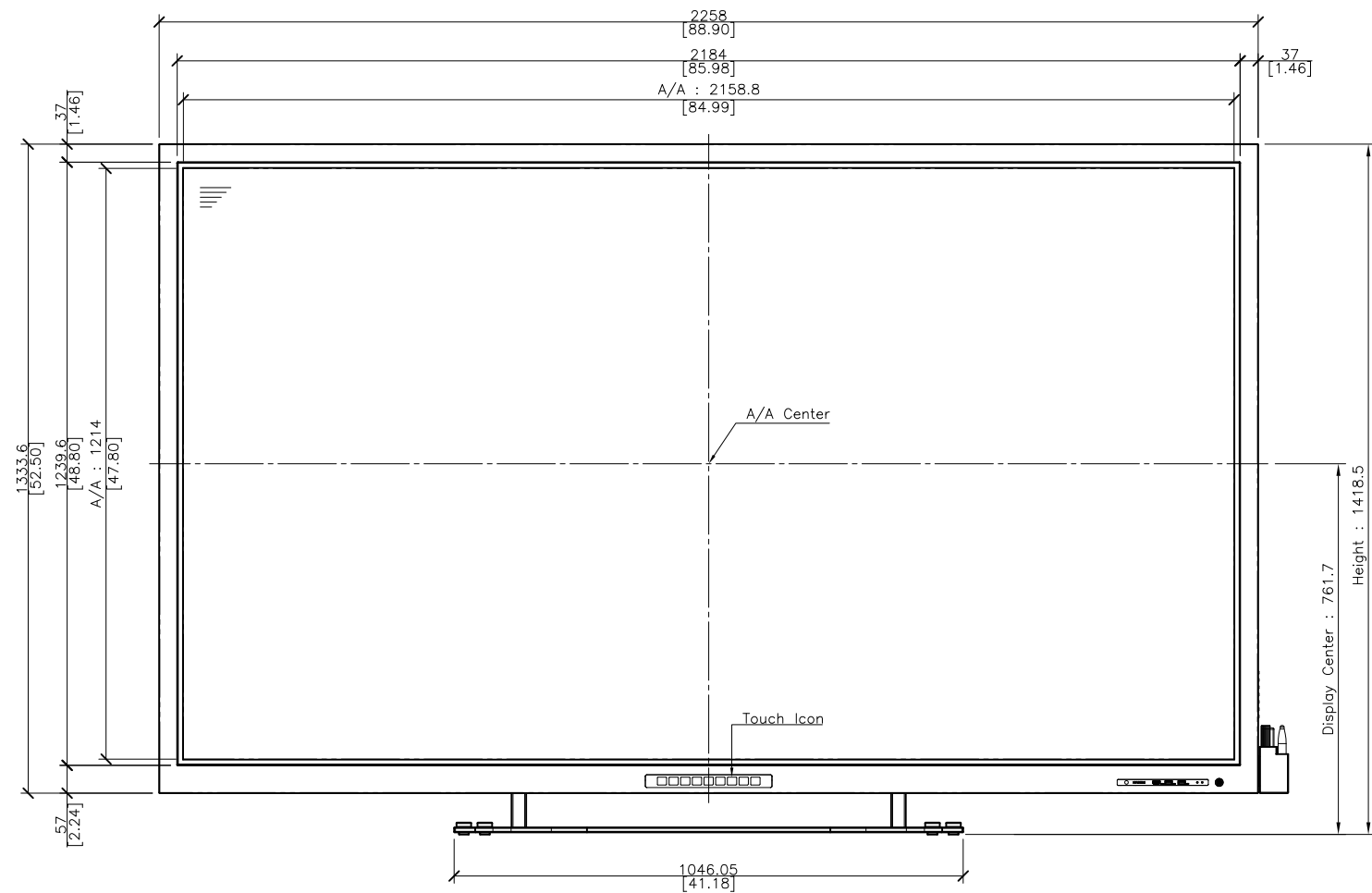
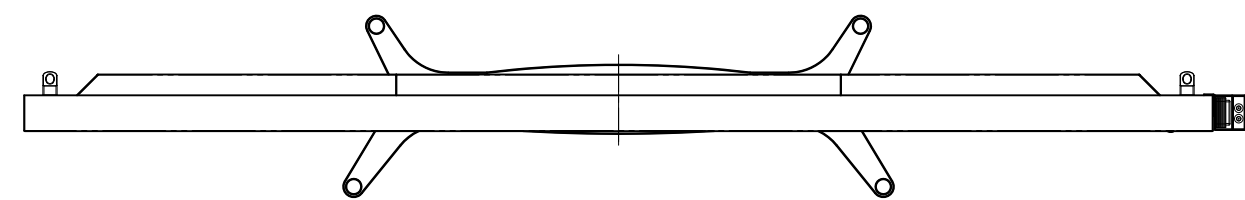

- NOTES,**
1. LCD Panel : 98"
 2. Tempered Glass : 5.0t
 3. Color : Black

DRAWN	PLANNED	CHECKED	APPROVED	TOLERANCES UNLESS OTHERWISE SPECIFIED ARE IN MILLIMETERS	ANGLE	TITLE	UNIT
S.W.SHO	S.HIANG	S.HIANG	Y.T.KIM	TOLERANCES ARE ANGLES : X ± 0.10 X ± 0.1 XX ± 0.01	30°	E98UAEL EXTERIOR VIEW	mm
18.11.17	18.11.17	18.11.17	18.11.17	RADIUS UNLESS NOTED : R 0.3	SCALE : NS	DWG(PART NO. E98UAEL_001)	PART
HYUNDAI IT CO., LTD.				MODEL NAME (CODE) : E98UAEL	CUSTOMER : HDT	DWG REV : 00	SIZE : A1
				FILE NAME : LAYOUT_E98UAEL_171118.DWG	SHEET NO : 1/1		