

REV. NO	DWG PART	REV. HISTORY	LTR	ECO NO	DATE	APPRL
00	00	INITIAL RELEASE	-	-	-	-

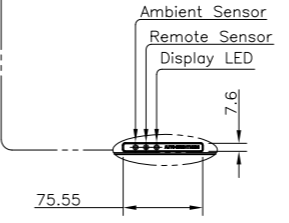
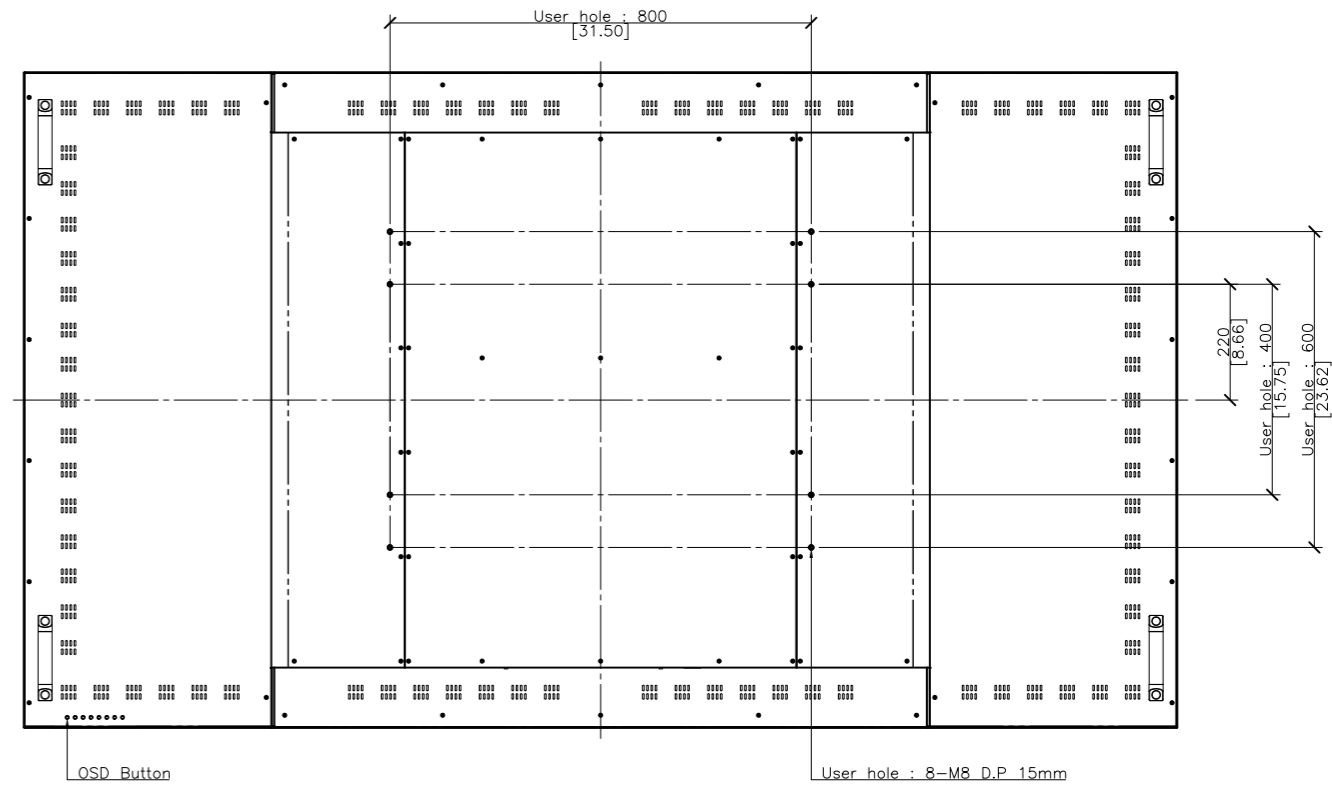
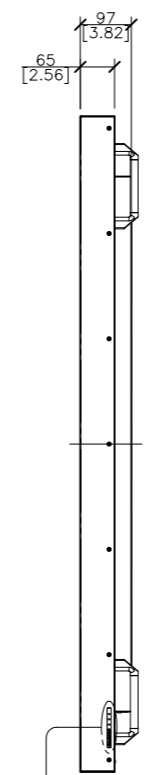
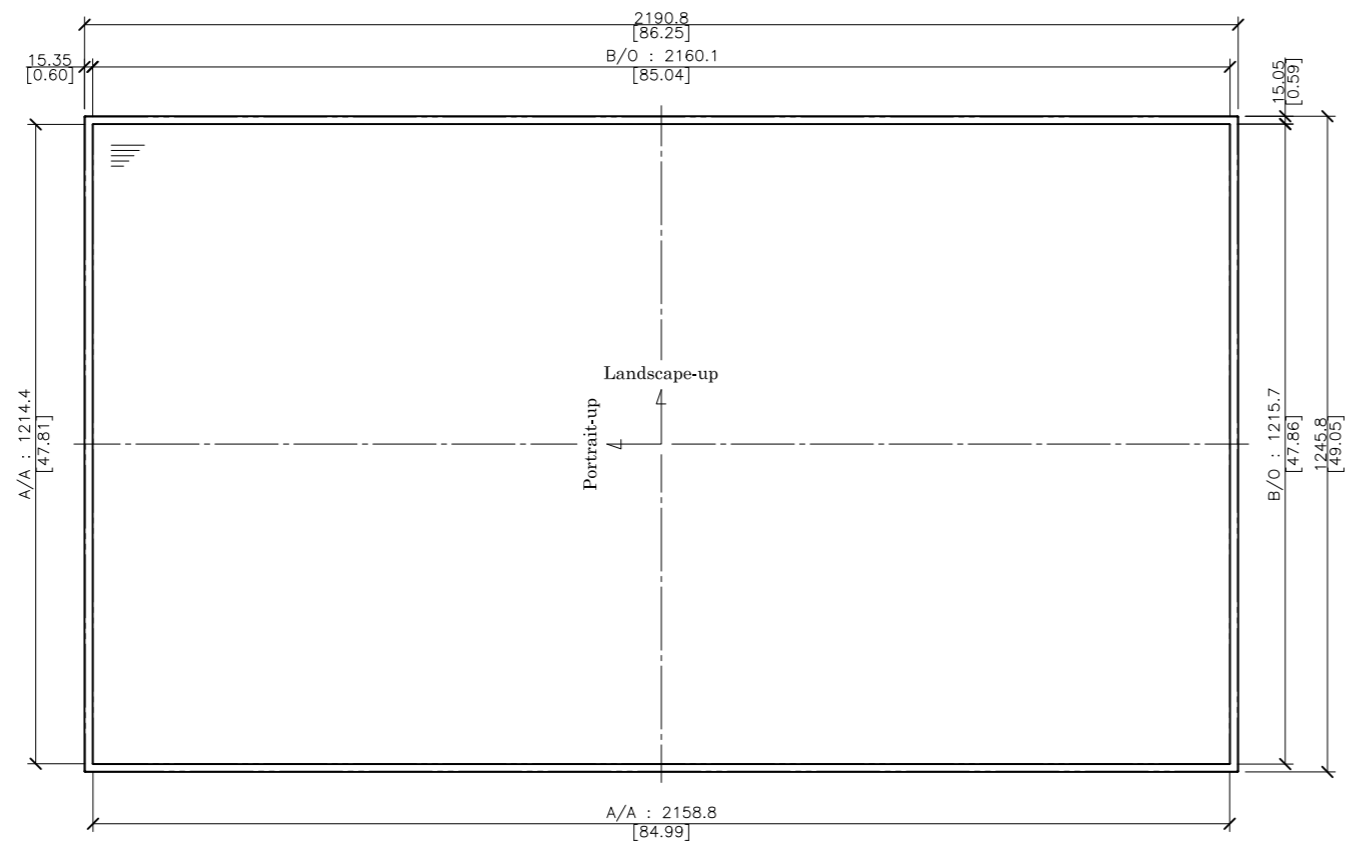
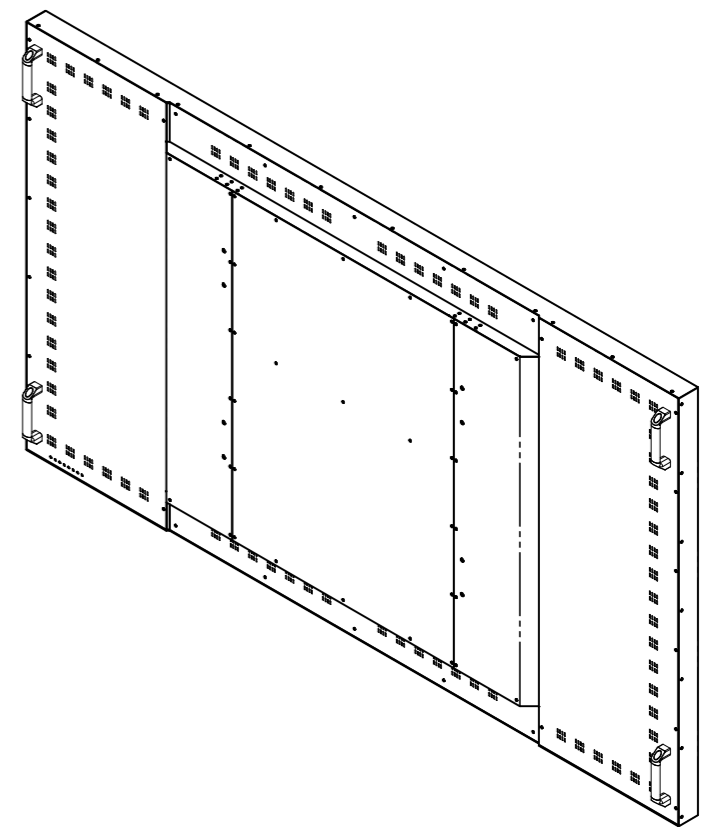
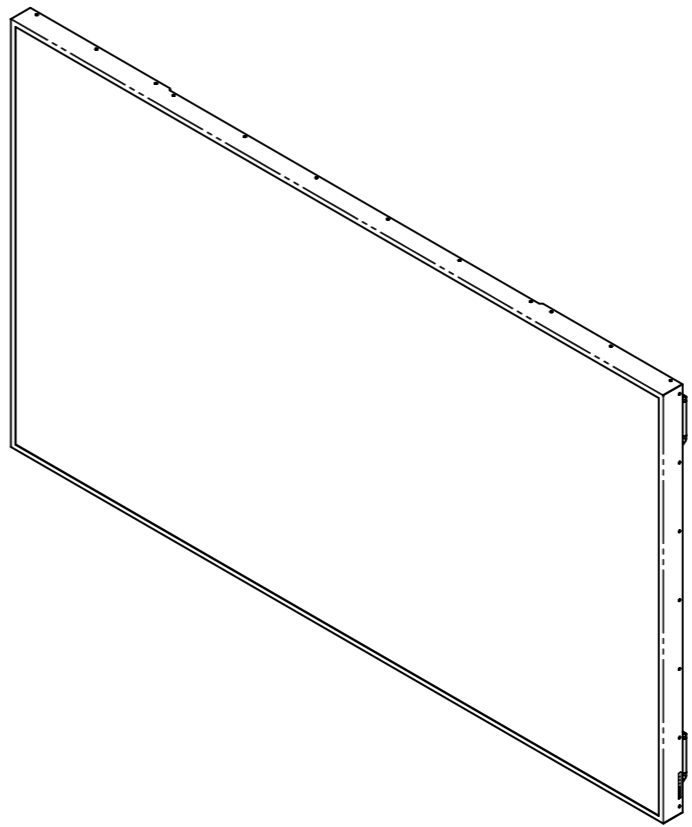
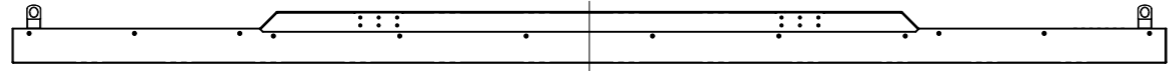

- NOTES
- LCD Panel : 98"
 - Tempered Glass : 5.0t
 - Color : Black

DRAWN	PLANNED	CHECKED	APPROVED	UNLESS OTHERWISE SPECIFIED ALL DIMENSIONS ARE IN MILLIMETERS	ANGLE	TITLE	UNIT
S.W.SEO	S.H.JANG	S.H.JANG	Y.T.KIM	TOLERANCES ARE: ANGLES : X ± 0.1° RADIUS UNLESS NOTED : R 0.3	30°	D98XMNG EXTERIOR VIEW	mm
13.02.02	13.02.02	13.02.02	13.02.02			DWG(PART) NO. D98XMNG_001	mm
HYUNDAI IT CO., LTD.				MODEL NAME (CODE) D98XMNG	CUSTOMER HDT	DWG REV : 00	SHEET NO : 1/1

This drawing is the property of HYUNDAI IT CO., LTD. and should not be disclosed to any third party without prior permission of HYUNDAI IT CO., LTD.